

Measuring of Total Gaseous Mercury
(TGM) in Air and other Gases at
Ultra Trace Levels.













UT 3000

Mercury Ultratracer



Applications

-  Air quality studies
-  Monitoring of indoor air pollution
-  Environmental pollution source tracking
-  Plume profiling
-  Studies of mercury dispersion in the atmosphere
-  Studies of interaction between atmosphere and surfaces
-  Pollution prevention
-  Natural gas and derivatives
-  Hydrogen and other gases
-  Soil and ground degassing studies

Mercury
in air and gases



Mercury
stack monitors



Mercury
laboratory analyzers



Mercury
process analyzers



Measurement of Total Gaseous Mercury in Air or Other Gases at Ultratrace Levels

The UT-3000 Mercury UltraTracer provides a compact and reliable tool for measuring mercury in gases at ultra trace levels. Utilizing the high performance GoldTrap amalgamation module and an optimized state-of-the-art AA-mercury vapor detector the UT-3000 UltraTracer offers detection limits at sub-ng/m³ (ppq-parts per quadrillion) levels.



Automatic Operation

The UT-3000 operates automatically. All functions are controlled by an embedded microprocessor. Once the analysis has been started, measurements are performed and data is collected by the built-in datalogger. With standard settings the datalogger has a recording capacity of 4 weeks.

GoldTrap Amalgamation System

For use in the UT-3000 a new trapping system has been developed: the Mercury GoldTrap, which is one of the key components of the system. It consists of a wafer thin ceramic tube which has been carefully crafted to achieve minimum thermal inertia. The tube has been packed with ultrapure gold and supports a heating coil on its outside. The Mercury GoldTrap reveals sharp and high peaks and an excellent long-term stability. As air is used for purging the trap during the heating step, possible contaminations are oxidized and swept off thus preventing from passivation.

Atomic Absorption Detector

The detector used in the UT-3000 provides a maximum of sensitivity, precision and stability. A high frequency driven electrodeless mercury low pressure lamp is used as UV light source. It generates a 253.7 nm emission line of an extremely narrow bandwidth which is congruent with the absorption line of the Hg atoms measured. The reference beam method is applied to get an exceedingly high stability of the UV source. The mercury concentration is measured in an optical cell which

has been made entirely of fused silica (Suprasil).

Thanks to the sensitivity enhancement provided by the GoldTrap there is no need for a long path cell which always has a greater surface effect. Recent solid state UV detectors with subsequent digital signal processing are used for absorption measurement.

Sampling

It is essential that the trap is free of mercury before sampling. This is ensured by a cleaning step which is automatically performed.

To keep particles out of the system and to protect the trap from passivation, a filter is installed upstream the sample inlet. The filter is made of low-interactive material; the filter membrane has a porosity of 0.45 µm and is made of PTFE. The complete filter unit is easily replaceable.

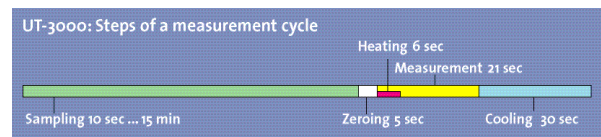

Sample Flow Control

The sample flow is measured with a high precision electronic mass flow meter. The flow rate integrated over time gives the total sample volume. The flow is automatically changed to a lower value during the desorption step to achieve maximum sensitivity.

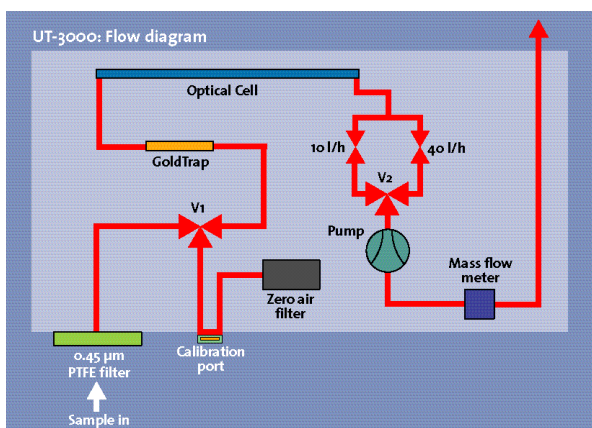

Calibration

There are two methods to check and calibrate the instrument:

One way is to capture mercury on the GoldTrap by bubbling air through a liquid mercury standard to which stannous chloride solution has been added.

Another quick, accurate, and precise way is the static calibration with mercury saturated air. Gaseous mercury is injected directly onto the GoldTrap. In this case the built-in calibration port is used which is internally connected to the sample gas line leading into the GoldTrap. The calibration port is equipped with a septum through which gaseous mercury is injected with a syringe. The type of syringe used for this purpose is specially designed to measure and dispense gases. The mercury is then automatically drawn onto the GoldTrap. Calibration gas sources are available as accessories. The calibration check procedure can be automatized as an option.

How does the UT-3000 work?

The Mercury Instruments GoldTrap is used to capture total gaseous mercury (TGM) directly from the atmosphere. GoldTraps work because mercury sticks to gold at room temperature. A gas carrying gaseous mercury is pulled through the trap; the gas continues to flow through the trap but the mercury stays behind--trapped on the gold. After the mercury is captured, the GoldTrap is heated very quickly; this releases the mercury as a gas (thermal desorption). The gaseous mercury is then swept by the flow of purified mercury free air into the optical cell of the detector. Here the mercury is measured by atomic absorption spectrometry.

Display and Output of Measurements

The results of the measurements are displayed on a graphic LCD as a bargraph and numerically. It is possible to view past readings with a paging function. Calibrations are stored in a non-volatile memory. The device has a serial interface for data transfer to a PC and a 0-20 mA output.

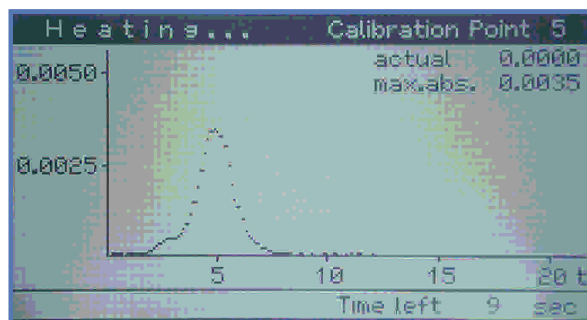

UT-3000: Peak during thermal desorption of Hg from GoldTrap.

Advantages of the AA Detection Method

The latest AA detection technique used in the UT-3000 offers some clear advantages over other methods. Mercury trace detection by fluorescence must use a carrier and sometimes a sheath gas and suffers from the quenching effect which can never be completely eliminated.

The UT-3000 requires no expensive gases for operation and there are no negative interferences caused by the quenching effect.

Sensitivity and detection limits are far superior to those instruments based on measurement of electrical resistivity of a thin gold film.

UT-3000: Graphic display of measurements.

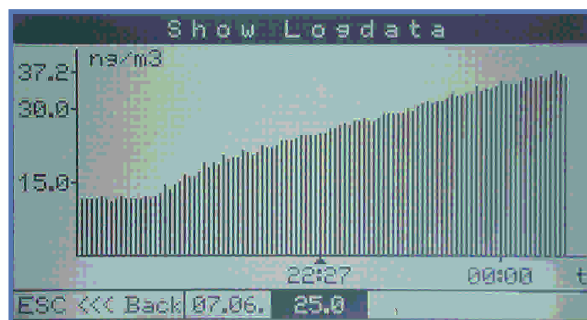

Case study mercury in laboratory air. The data show an increase of Hg during shutdown of room ventilation system.

Mercury Ultratracer 3000 Technical Specifications

Measuring principle:	Preconcentration of mercury onto gold trap and subsequent release by fast heating, detection by AA
Mercury collector:	Proprietary MI GoldTrap
Detector:	Advanced AA photometer with stabilized electrodeless mercury discharge lamp, wavelength = 253,7 nm
Sample volume:	0.1 l to 100 l
Sampling duration:	10 seconds to 15 minutes
Measurement cycle time:	10 seconds to 16 min
Detection limit:	<0.1 ng/m ³ corresponding to 0.5 pg Hg absolutely
Measuring range:	at 10 l sample volume: 0.1 ng/m ³ to 2000 ng/m ³ at 1 l sample volume: 1 ng/m ³ to 10000 ng/m ³
Sample volume determination:	Electronic massflow meter
Sample pump:	Membrane pump, Viton
Sample inlet:	0.45 µm PTFE membrane filter, disposable
Calibration port:	PTFE coated silicone rubber septum
Carrier gas:	Not required
Data display:	Display of realtime signal reading during gold trap heating period, display of measurement results in a barcode diagram
Data logger function:	Built-in data logger for record of 10000 measurements (up to 100 days)
Data output:	Via RS232 to a computer (PC or Laptop)
Calibration:	Through calibration gas injection port, manually using calibration gas source and syringe (optionally available), automatic with calibration source (option)
Power supply:	110 V or 230 V 50/60 Hz
Power consumption:	Max. 125 W (heating peak)
Dimensions:	45 x 15 x 35 cm (W x H x D)
Weight:	Approx. 9 kg
Temperature range:	5°C to 35°C
Accessories:	Calibration set for static calibration Automatic calibration device MC-3000 Dynamic Calibration Gas Generator Carrying case with handle and wheels Mains independent power supply pack

The Response to an Analytical Challenge: Mercury Instruments.

Quantitative trace analysis of mercury has been a challenging task for the analyst until now. We from MERCURY INSTRUMENTS have made it our job to develop instruments for mercury analysis of the highest technical level. The range of applications for our mercury analyzers is unique world-wide.



Mercury Instruments GmbH
Analytical Technologies

Liebigstraße 11b
D-85757 Karlsfeld

Tel.: +49 (0)8131 - 50 57 20
Fax: +49 (0)8131 - 50 57 22

mail@mercury-instruments.de